







AMBARIS

Ethereal Experience

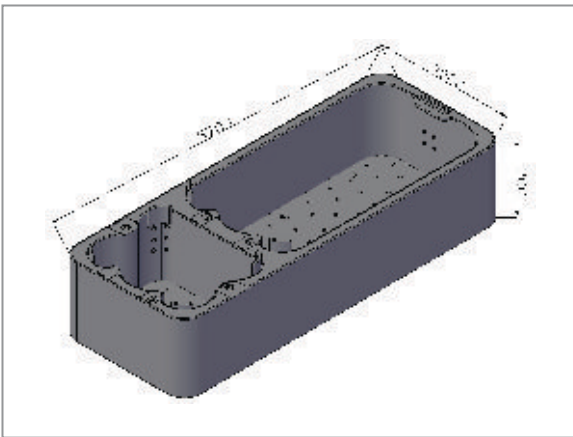
DRAWING

Size - 5700 x 2200 - 1200h



Location of drain 
 Location of cold and hot water connections  
 Location of electrical connections 

TECHNICAL

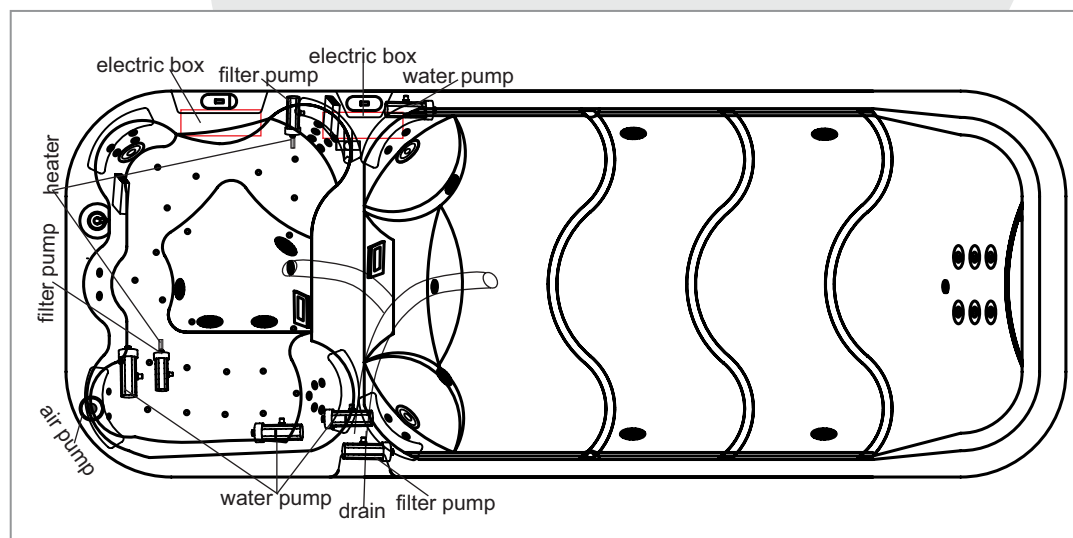
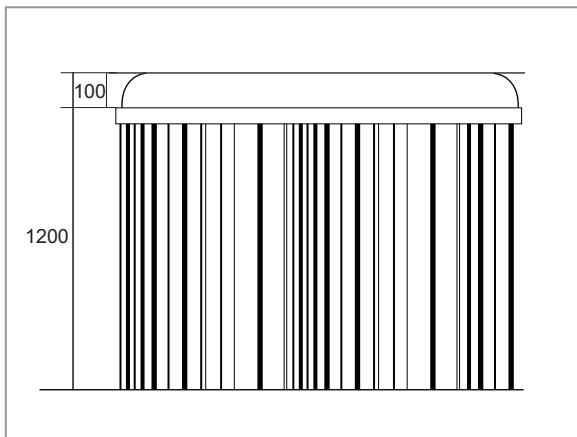

PRE-INSTALLATION

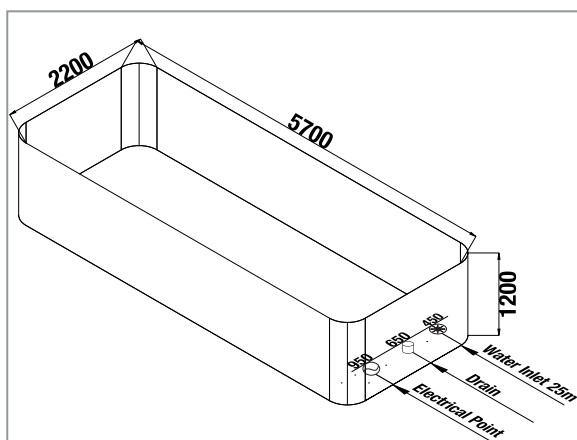

Normal

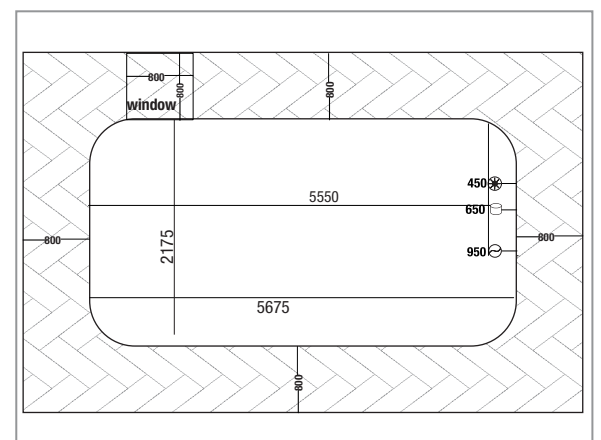

Built-In